

User Manual

Profiler Revolution Lite
Ref. 6701

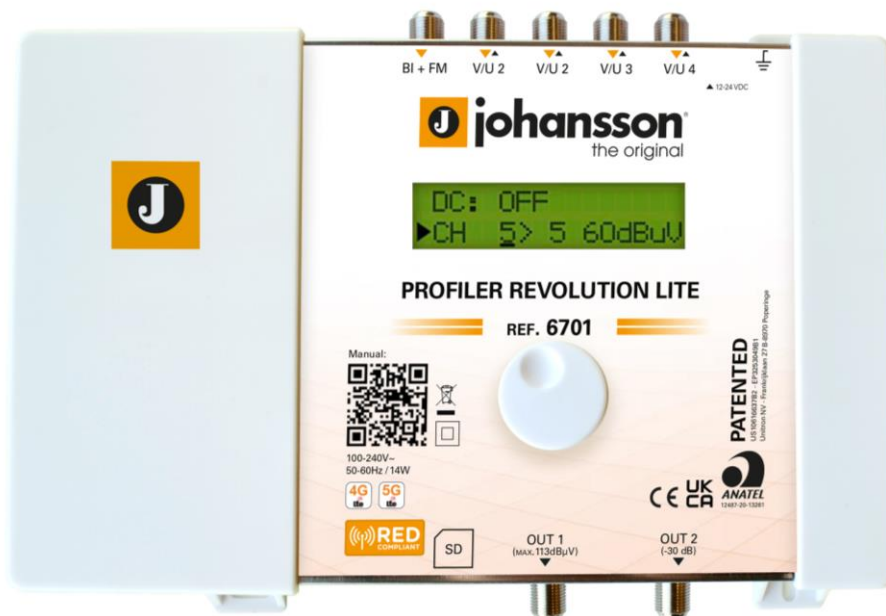

PATENTED TECHNOLOGY

SW Version 1.7.0

CONTENTS

1. INTRODUCTION	3
1.1. Product description	3
1.2. Typical installation	3
1.3. Package contents	3
1.4. Hardware installation	4
1.5. Mounting the Profiler Revolution Lite	4
1.6. Configuring the Profiler Revolution Lite	5
2. TECHNICAL SPECIFICATIONS	11
3. BLOCK DIAGRAM	12
4. SAFETY INSTRUCTIONS	13
5. CONDITIONS OF WARRANTY	14

No part of this manual may be copied, reproduced, transmitted, transcribed or translated into any language without permission.

Unitron reserves the right to change the specifications of the hardware and software described in these manuals at any time.

Unitron cannot be held liable for any damages resulting from the use of this product. Specifications are subject to change without notice. 03/22

© Unitron - Frankrijklaan 27 - B-8970 Poperinge - Belgium

T +32 57 33 33 63 **F** +32 57 33 45 24

sales@unitrongroup.com

www.unitrongroup.com

1. INTRODUCTION

1.1. Product description

The Johansson Profiler Revolution Lite is an easy to use programmable filter amplifier and convertor for terrestrial signals. The module optimizes terrestrial VHF/UHF and FM signals from multiple inputs with the goal to provide high quality images on your TV screen. The state-of-the-art programmable filter amplifier has no equivalent on the market due to its revolutionary technology:

- Can process more than 50 channels (32 filters)
- Can convert a wide selection of channels
- Sharpest filters on the market (50 dB on adjacent channels)
- Real-time AGC on all individual filters
- Complete flexibility in assigning filters from any input. Each channel can be frequency shifted to any other channel in the VHF or UHF band (Flex Matrix)
- To avoid unauthorized persons changing the settings, all Profiler products can be locked with a security code
- Made in Europe, for worldwide application
- 5 inputs: BI+FM / 4 x VHF-UHF / > 50 channels / AGC / 12-24 V remote power
- Product dimensions (H X W X D): 165mm x 217mm x 59mm

1.2. Typical installation

The Profiler Revolution Lite can be used to provide high quality television images and FM signals in a wide range of projects, both in the hospitality as in the residential market. Typical buildings or infrastructures where the Profiler Revolution Lite can be used include, but are not limited to:

- Large and small hotels, hostels, bed and breakfasts, holiday parks
- Hospitals, rest homes, prisons, settlements
- Large and small multi-dwelling units

1.3. Package contents

- 1 Profiler Revolution Lite (ref. 6701)
- 1 Power Adapter Cord (180cm)

1.4. Hardware installation

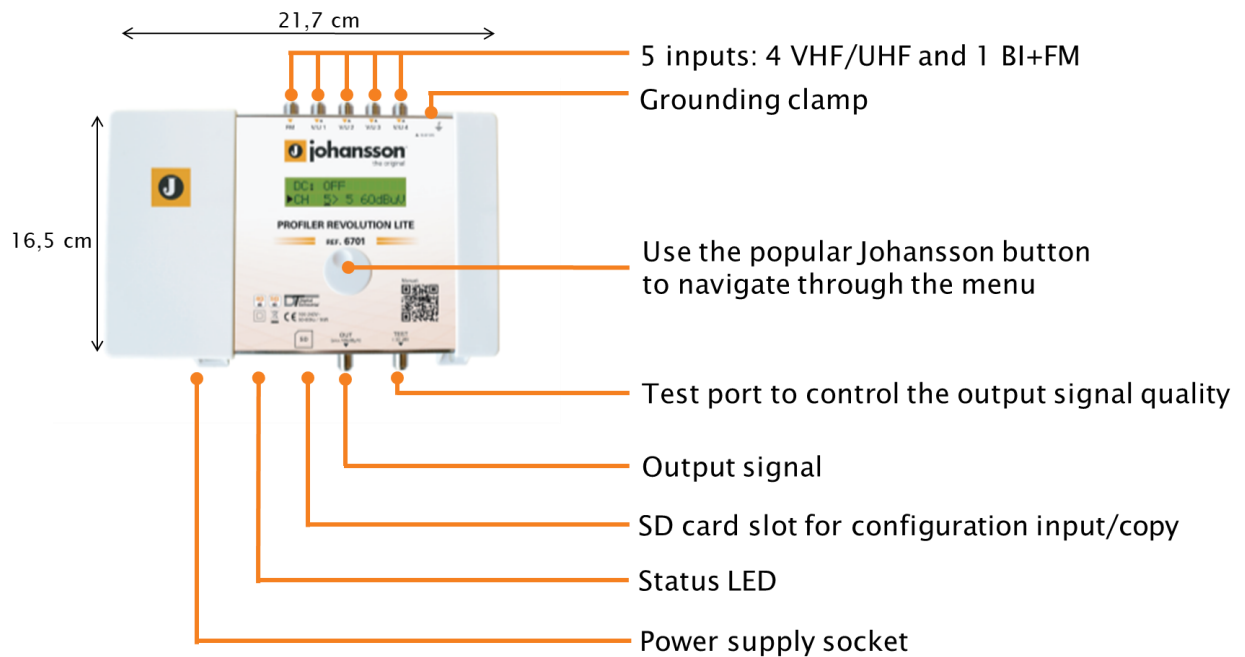
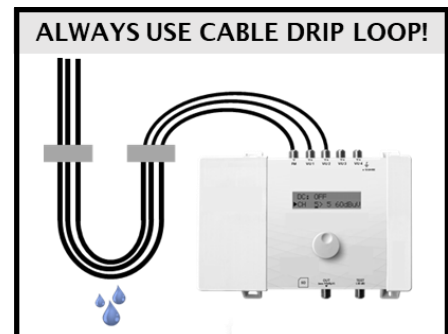

FIGURE 1: TOP VIEW OF PRODUCT

1.5. Mounting the Profiler Revolution Lite



- **Important:** Mount the module vertically to a wall in a well-ventilated room and leave a minimum space of 15 cm around the product to guarantee a maximum ventilation of the product
- Connect an earth wire to the grounding clamp
- Connect the power adapter cord to the power supply socket. Check the status LED for the indication of DC power presence
- Connect the VHF/UHF and/or BI+FM inputs to the Profiler Revolution Lite
- Connect a coaxial cable to the output connector for distribution of the signal
- Connect a network analyser to the test port to control the signal quality
- Configure the Profiler Revolution Lite using the rotary button, see below
- Optionally: insert an SD card in the SD card slot to upload the configurations of a previous module or to copy the configuration to another module
- The power adapter can easily be replaced without disconnecting the product. To do so, open the top left plastic cover by pushing the click at the opposite side of the mains connector



1.6. Configuring the Profiler Revolution Lite

NAVIGATING THROUGH THE MENU

Use the Johansson rotary/push button to navigate through the menu. This is very straightforward and simple. The table below shows how the rotary/push should be used:

	<p>Push the button 2s to enter the basic configuration.</p> <p>Push the button to confirm your selections.</p>
	<p>When rotating the button, you scroll through the different screens.</p>

MENU OVERVIEW

◀▶	INPUT BI+FM	INPUT V/U 1 - 4	OUTPUT	ADVANCED	LOAD SD PRESET	SAVE SD PRESET	EXIT	▶▶
	GAIN	PRE-AMPLIFIER	LEVEL	LANGUAGE	PRESET X	CREATE PRESET	LOCK	
◀▶		DC	SLOPE	REGION		DELETE ALL	NO LOCK	▶▶
		ADD CHANNEL	VHF ATTN	DC VOLTAGE				
				BANDWIDTH				
				FW VERSION				
				SERIAL NUMBER				
				FORMAT CARD				

REGION/COUNTRY SETTINGS

IMPORTANT! Before starting the configuration, it is advised to set the correct region or country. Unpower the unit, push the button and keep pushing the button while you repower the unit. Release the button when the display shows "RESET FINISHED". Now the product is reset and will ask you to enter country or region. This will amongst others determine the channel plan for VHF and UHF and the DC voltage for the inputs (12 or 24V).

DISPLAY READOUT

EXPLANATION



To activate the correct channel frequency plan, select the **country** or **region** where the Profiler Revolution Lite is situated. Rotate to select and confirm by tapping the rotary button.

The default setting is Europe. The Profiler Revolution Lite is also operational in the following countries/regions: Australia, Brazil, China, Hongkong, Italia, New-Zealand, Russia, South Africa, UK and USA.

All the following menu items can be accessed without the reset procedure.

Push the rotary button for 2 seconds to access the menu

INPUT SETTINGS

DISPLAY READOUT

EXPLANATION



Tap the rotary button to enter the INPUT BI+FM menu. Rotate the button to navigate through the submenu.



To filter and amplify a BI+FM signal, tap GAIN, select the gain of the input BI+FM signal (15 to 35 dB) and tap to confirm.

Remark: DAB should be added via V/U input 1-4.



After INPUT BI+FM is configured, scroll up to the top of the menu (INPUT BI+FM), tap the rotary button and scroll right to INPUT V/U 1. Tap INPUT V/U 1 to enter the menu to configure input 1.



Rotate the rotary button to scroll down in the submenu of INPUT V/U 1.



PRE-AMPLI: The internal amplifier is by default ON, only in case of very strong incoming signals (if the strongest channel on that input is higher than 80dBµV), it can be advised to switch this OFF.



DC: Decide whether the input should provide power to an external amplifier. Choose between OFF or 12 V. Remark: If the external amplifier needs 24 V, you can change this in advanced settings (see further).



DISPLAY READOUT	EXPLANATION
	<p>Tap Add Channel to add channel. Up to 6 channels can be added at once.</p>
	<p>First select the starting channel (e.g. CH5) and tap to confirm. Then select the stop channel (e.g. CH7, this means that you will add 3 channels). Tap to confirm. Then you can convert them using the rotary button (e.g. CH5 to CH7 converts to CH8 to CH10) and tap to confirm.</p>
	<p>Some other examples: To add CH5 and convert to CH6, select as follows: 5: 5 → 6: 6</p>
	<p>To add CH21-22-23 and convert to CH31-32-33, select as follows: 21:23 → 31:33</p>
	<p><u>Remark 1:</u> The value 85dBμV (in the bottom right corner) indicates the incoming level of the channel. <u>Remark 2:</u> For EU, Italy and New-Zealand region, Channel 13 (230-240MHz) can be used. CH13 cannot be converted. <u>Remark 3:</u> A star (*) will appear when converting to a different channel bandwidth: e.g. from a 7MHz channel to an 8 MHz channel</p>

For optimal performance we recommend to only add single channels, unless you need to process a lot of channels.



DISPLAY READOUT	EXPLANATION
	<p>To add another (group of) channel(s), scroll down to ADD CHANNEL and tap to confirm. To prevent bad quality or scrambled images, make sure that only one input channel is assigned to one output channel. If 2 channels are assigned to the same output channel, a star (*) will appear.</p>
	<p>The same applies for adding multiple channels. Make sure that each output channel is selected only once.</p>

After this, the correct LTE filter will be set for the UHF inputs (possible filters are 694MHz, 790MHz or OFF). If the channels are lower than 48, the 694MHz filter is activated. The 790MHz filter is activated for the channels lower than 60.

To delete a (pair of) channel(s), position the arrow on the channel and press the rotary button 3 seconds.





DISPLAY READOUT	EXPLANATION
	To delete a (pair of) channel(s), position the arrow on the channel and press the rotary button 3 seconds.
	When you have added all the channels to INPUT V/U 1, and you want to add channels to the other inputs, scroll up to the top of the menu (to INPUT V/U 1), tap the button and scroll to the next input. Repeat the previous steps for all input channels.

OUTPUT SETTINGS



DISPLAY READOUT	EXPLANATION
	Define the OUTPUT LEVEL of the output signal. Range between 93 dB μ V and 113 dB μ V (default output level is 103 dB μ V). Check the output via a network analyser on the -30dB test port. Note: The more channels you select, the less input power you should give (e.g. 99 dB μ V for 10 channels).
	A SLOPE of up to -15dB can be set between the beginning of BIII and the end of UHF to compensate for cable losses. 0dB means all channels have the same output level (see previous display readout), -15dB means the beginning of BIII (174MHz) is 15dB weaker than the end of UHF.
	VHF ATTN: To compensate for cable losses, an attenuator of up to 15 dB can be configured to decrease the VHF and DAB output level (compared to the UHF output level).

Note: In the OUTPUT menu, you define the output level in dB μ V of the MUX's. The Profiler Revolution has enough gain to guarantee this output level under all input conditions. In case a slope has been set, the output level indicated on the display will be the output level of the highest frequency MUX.



ADVANCED SETTINGS

DISPLAY READOUT	EXPLANATION
	<p>The language of the Profiler Revolution can be set to English, Italian, Spanish or French.</p>
	<p>Tap REGION to check to which region/country the Profiler Revolution is set. To change the region/country, a hard reset is required (see instructions above (cfr. REGION/COUNTRY SETTINGS)).</p>
	<p>Define DC VOLTAGE for the inputs, choose between 12V or 24V. This is a global setting for all inputs, each input can then be switched between OFF or this value. (cfr. STEP 2). All countries are set by default on 24V, except UK which is set by default on 12V.</p>
	<p>The filter bandwidth can be changed from -2000 kHz to 0 kHz in steps of 250 kHz. This allows you to optimize the bandwidth of your filter. For instance, a European 8 MHz channel can be changed from 6 to 8 MHz. The default setting is -750 kHz, which is an optimal setting in 95% of the cases.</p> <p>Tap FW VERSION to check the firmware version of the device. Tap SERIAL NUMBER to check the serial number of the device. To format the SD CARD, tap FORMAT CARD.</p>

SD CARD SETTINGS

DISPLAY READOUT	EXPLANATION
	<p>To upload settings from a SD card, tap LOAD SD PRESET. This will copy the configuration file from the SD CARD to the device.</p>
	<p>To save the device settings on the SD CARD, go to SAVE SD PRESET and tap on CREATE PRESET.</p>
	<p>It is possible to create multiple presets. Therefore, tap CREATE PRESET after each modification of the settings. To delete all presets, press DELETE ALL.</p>

EXIT SETTINGS

DISPLAY READOUT	EXPLANATION
 <p>▼EXIT LOCK</p>	<p>To avoid unauthorized people changing the settings, all Profiler products can be locked with a security code.</p>
 <p>SET LOCK CODE 11</p>	<p>Select LOCK and SET LOCK CODE. When the lock code is set, the device will shut down.</p>
 <p>ENTER LOCK CODE 0</p>	<p>When you restart the device, you will now have to enter the correct lock code. <u>Remark:</u> If you forgot the lock code, you can always use the value 50. This master code is fixed and cannot be changed. If you do not want to work with a lock code, go to EXIT and tap NO LOCK.</p>

2. TECHNICAL SPECIFICATIONS

Profiler Revolution Lite 6701		
Inputs	-	4 VHF/UHF + 1 BI+FM
Outputs	-	1 main (BI+FM-VHF-UHF) + 1 test port (-30dB)
Frequency range	MHz MHz MHz	BI+FM: 47 - 108 VHF:174 - 240 UHF: 470 - 862
LTE protection	MHz	Automatic selection: 694, 790 or OFF
Input level	dB μ V dB μ V dB μ V	BI+FM: 37 - 77 VHF: 37* - 109 UHF: 37* - 109
BI+FM Output power (60dB/IM3)	dB μ V	113
VHF/UHF Output power (60dB/IM3)	dB μ V	115
VHF/UHF Output power (36dB/IM3)	dB μ V	126
VHF/UHF Output power with 1 MUX	dB μ V	113
VHF/UHF Output power with 6 MUX	dB μ V	108
Add channels	-	Per 1, 2, 3, 4, 5 or 6 MUXes
Number of channels	-	More than 50 (32 filters)
Conversion	-	Yes (from any VHF-UHF channel to any VHF-UHF channel)
Gain	dB dB dB	BI+FM: 35 VHF: >65 UHF: >65
Gain adjustment: BI+FM	dB	20
VHF/UHF	-	Channel AGC
General attenuator	dB	20
Slope adjustment	dB	15
VHF/DAB attenuator	dB	15
Noise figure	dB	7
Selectivity	dB/1MHz	35
Return Loss	dB	10
Output MER	dB dB	VHF: 35 UHF: 35
ESD protection	-	All inputs
Remote voltage for preamp	V	12 or 24
Remote current	mA	100 (total for the 4 inputs)
SD port	-	Yes (for copy configuration and upgrade features)
Operating temperature	°C	-5 to +50
Power Supply	Vac	100 - 240
Power consumption	W	14
Dimensions	mm	217 x 165 x 59
Weight	kg	0,8

* For 64QAM with code rate 3/4

3. BLOCK DIAGRAM

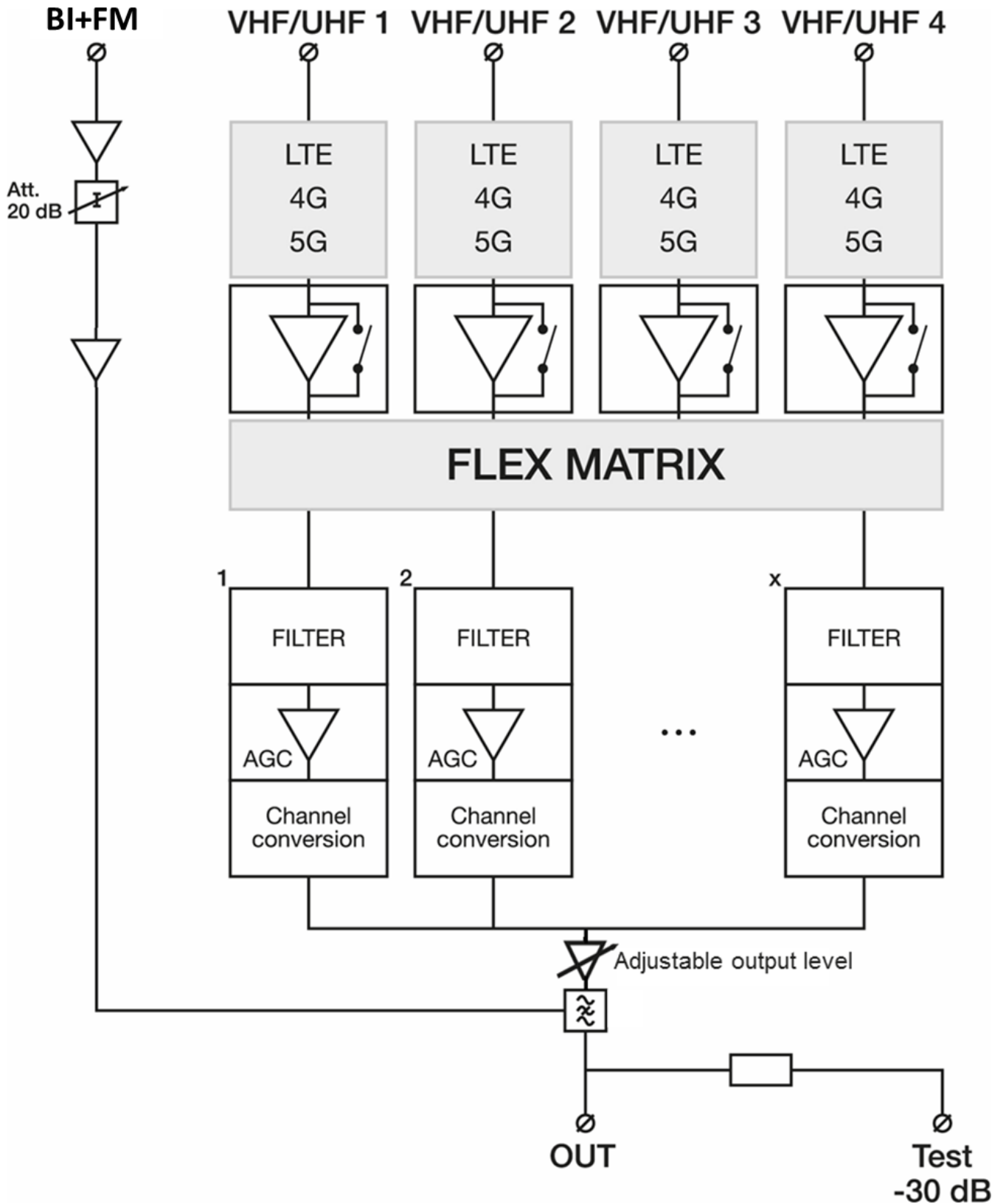

4. SAFETY INSTRUCTIONS



Read these instructions carefully before connecting the unit



To prevent fire, short circuit or shock hazard:

- Do not expose the unit to rain or moisture.
- Install the unit in a dry location without infiltration or condensation of water.
- Do not expose it to dripping or splashing.
- Do not place objects filled with liquids, such as vases, on the apparatus.
- If any liquid should accidentally fall into the cabinet, disconnect the power plug.



To avoid any risk of overheating:

- Install the unit in a well aired location and keep a minimum distance of 15 cm around the apparatus for sufficient ventilation
- Do not place any items such as newspapers, tablecloths, curtains, on the unit that might cover the ventilation holes.
- Do not place any naked flame sources, such as lighted candles, on the apparatus
- Do not install the product in a dusty place
- Use the apparatus only in moderate climates (not in tropical climates)
- Respect the minimum and maximum temperature specifications



To avoid any risk of electrical shocks:

- Connect apparatus only to socket with protective earth connection.
- The mains plug shall remain readily operable
- Pull out power plug to make the different connections of cables
- To avoid electrical shock, do not open the housing of adapter.



Maintenance



Only use a dry soft cloth to clean the cabinet.



Do not use solvent



For repairing and servicing refer to qualified personnel.



Dispose according your local authority's recycling processes

5. CONDITIONS OF WARRANTY

Unitron N.V. warrants the product as being free from defects in material and workmanship for a period of 24 months starting from the date of production indicated on it. See note below.

If during this period of warranty the product proves defective, under normal use, due to defective materials or workmanship, Unitron N.V, at its sole option, will repair or replace the product. Return the product to your local dealer for reparation.

THE WARRANTY IS APPLIED ONLY FOR DEFECTS IN MATERIAL AND WORKMANSHIP AND DOES NOT COVER DAMAGE RESULTING FROM:

- Misuse or use of the product out of its specifications,
- Installation or use in a manner inconsistent with the technical or safety standards in force in the country where the product is used,
- Use of non-suitable accessories (power supply, adapters...),
- Installation in a defect system,
- External cause beyond the control of Unitron N.V. such as drop, accidents, lightning, water, fire, improper ventilation...

THE WARRANTY IS NOT APPLIED IF

- Production date or serial number on the product is illegible, altered, deleted or removed.
- The product has been opened or repaired by a non-authorized person.

NOTE

Date of production can be found in the product's serial number code. The format will either be "YEAR W WEEK" (e.g., 2017W32 = year 2017 week 32) or "YYWW" (e.g., 1732 = year 2017 week 32).



www.unitrongroup.com

UNITRON NV
Frankrijklaan 27
B-8970 Poperinge
Belgium

T +32 57 33 33 63
F +32 57 33 45 24

sales@unitrongroup.com

www.unitrongroup.com